

Imię i nazwisko \_\_\_\_\_ /60

Klasa \_\_\_\_\_

**Zadanie 1**

(0-5)

Usłyszysz dwukrotnie pięć tekstów. W zadaniach 1.1.–1.5., na podstawie informacji zawartych w nagraniu, z podanych odpowiedzi wybierz właściwą. Zakreśl jedną z liter: A, B lub C.

1.1.

What did the boy buy for his brother?

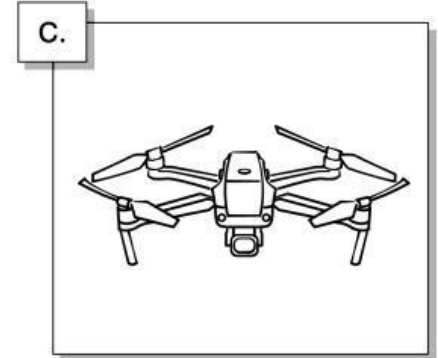
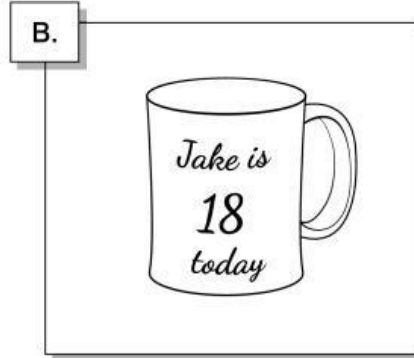
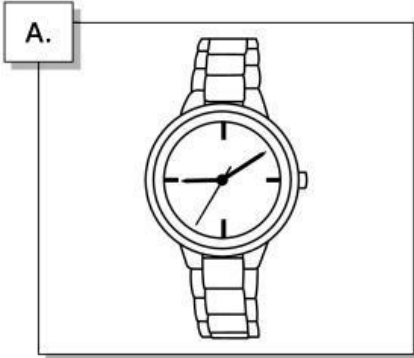

1.2.

What will Kate prepare for the school open day?

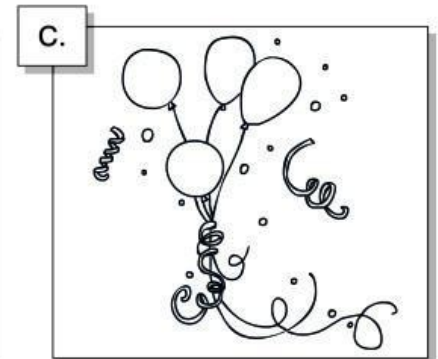
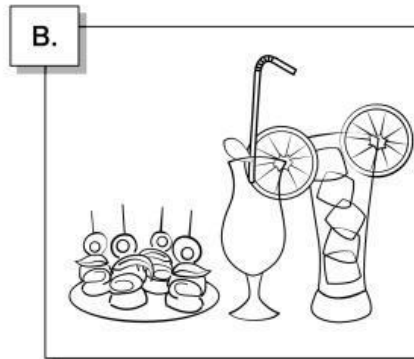
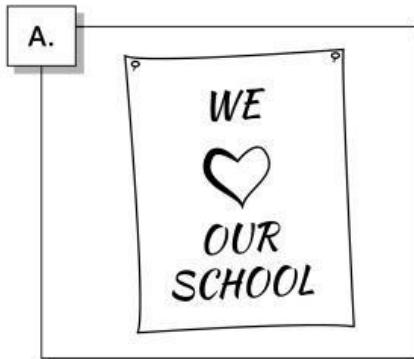

1.3.

Who is the boy talking to?

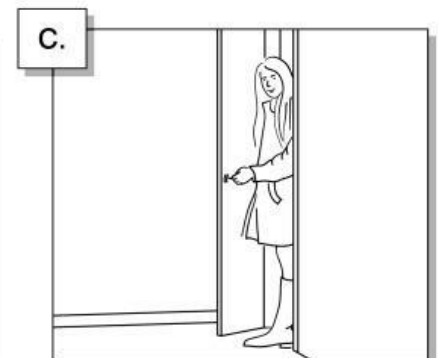
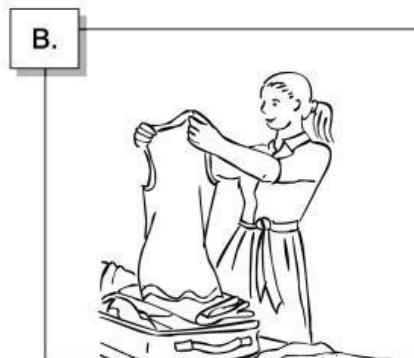
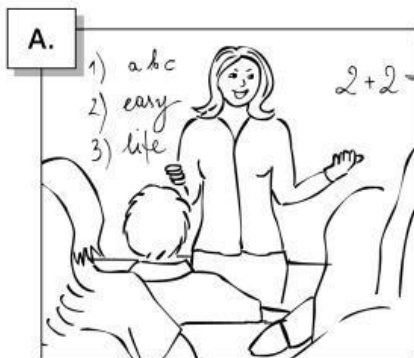

1.4.

The man is talking about

- A. past situations
- B. his job
- C. his hobby

1.5.

The girl is calling her mum to

- A. ask what is for dinner
- B. say that she will be late
- C. ask her to buy something

**Zadanie 2**

(0–4)

Usłyszysz dwukrotnie cztery wypowiedzi na temat zajęć pozalekcyjnych. Na podstawie informacji zawartych w nagraniu dopasuj do każdej wypowiedzi (2.1.–2.4.) odpowiadające jej zdanie (A–E). Wpisz rozwiązania do tabeli. Uwaga! Jedno zdanie podano dodatkowo – nie pasuje do żadnej wypowiedzi.

This person

- A. couldn't wait for the first class.
- B. thought that the classes had a surprising effect.
- C. had to work hard to succeed.
- D. found it too stressful to take part in classes.
- E. succeeded thanks to other people.

2.1.	2.2.	2.3.	2.4.

**Zadanie 3**

(0–4)

Usłyszysz dwukrotnie komunikat o festiwalu piosenki. Na podstawie informacji zawartych w nagraniu uzupełnij luki 3.1.–3.4. w notatce, aby jak najprecyzyjniej oddać sens wysłuchanego tekstu. Luki należy uzupełnić w języku angielskim. Uwaga! W każdą lukę możesz wpisać maksymalnie trzy wyrazy.

**The Singing Festival**

The singing contest is for participants up to 3.1. \_\_\_\_\_ years of age. Additional events during the festival are 3.2. \_\_\_\_\_ and \_\_\_\_\_. The additional events will take place during 3.3. \_\_\_\_\_ of the festival. You can 3.4. \_\_\_\_\_ at [www.joinfestkids.co.uk](http://www.joinfestkids.co.uk).

**Zadanie 4**

(0–4)

Usłyszysz dwukrotnie cztery wypowiedzi związane ze spędzaniem czasu wolnego (4.1.–4.4.). Do każdej z nich dobierz właściwą reakcję (A–E). Wpisz rozwiązania do tabeli. Uwaga! Jedną reakcję podano dodatkowo – nie pasuje do żadnej wypowiedzi.

- A. I haven't been there recently.
- B. To be honest, I don't like it.
- C. I can show you my favourite places if you like.
- D. Yes, I'm really looking forward to it.
- E. Sure, I'll be ready in a minute.

4.1.	4.2.	4.3.	4.4.

PRZENIEŚ ROZWIĄZANIA ZADAŃ 1., 2. ORAZ 4. NA KARTĘ ODPOWIEDZI!

**Zadanie 5**

(0–4)

Dla każdej z opisanych sytuacji (5.1.–5.4.) wybierz właściwą reakcję. Zakreśl jedną z liter: A, B lub C.

5.1. Koleżanka poprosiła cię o radę w sprawie ubioru na imprezę. Co jej powiesz?

- A. I need your advice about it.
- B. This looks good on you.
- C. I'm not sure whose dress this is.

5.2. Kuzynka proponuje ci wspólne wyjście na lody, ale nie masz czasu. Jak jej odmówisz?

- A. I'm sorry, I won't make it.
- B. Sorry, I'm not ready to do it.
- C. I'm sorry but I don't agree with you.

5.3. Twój kolega nie zauważył dużego przedmiotu leżącego na drodze. Ostrzeż go.

- A. Get ready!
- B. Take care!
- C. Watch out!

5.4. Koleżanka składa ci życzenia urodzinowe. Jak na nie zareagujesz?

- A. You don't need to say that.
- B. That's very nice of you.
- C. I wish you the best of luck.

**Zadanie 6**

(0–3)

Uzupełnij dialogi. Wpisz w każdą lukę 6.1.–6.3. brakujący fragment wypowiedzi, aby otrzymać spójne i logiczne teksty. Luki należy uzupełnić w języku angielskim. Uwaga! W każdą lukę możesz wpisać maksymalnie trzy wyrazy.

Dad, I don't know where I've put my favourite sweatshirt. Can 6.1. \_\_\_\_\_ look for it?

Sure. Have you checked the wardrobe?



Excuse me, do you 6.2. \_\_\_\_\_ the concert is?

Yes, it's in the main hall on the ground floor.



What 6.3. \_\_\_\_\_ about their new song?

I don't like it. It's different from the old ones.

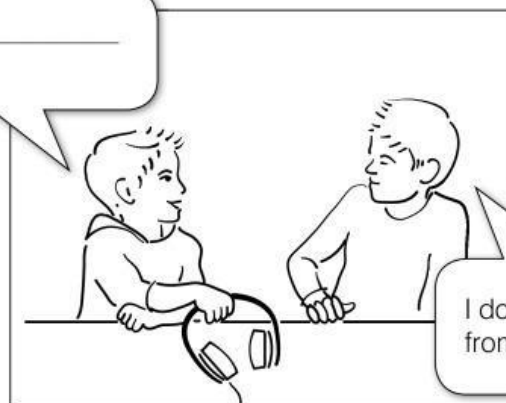

**Zadanie 7**

(0-4)

Przeczytaj teksty. W zadaniach 7.1.–7.4. z podanych odpowiedzi wybierz właściwą, zgodną z treścią tekstu. Zakreśl jedną z liter: A, B lub C.

7.1.

*School trip to Warsaw*  
*16 November*

- We meet in front of the school at 7.45. Don't be late.
- Bring some pocket money on you to buy souvenirs.
- Take warm clothes with you.

*See you all on Friday!*  
*Mr. Craig*

- 7.1. Both texts are about
- A. planning a trip
  - B. buying something
  - C. wearing the right clothes

7.2.

- 7.2 Rob is writing to
- A. invite Chris to his house
  - B. offer his help to Chris
  - C. thank Chris for something

7.3.

- 7.3. The correct order of the sentences in the message is
- A. 3-2-1-4
  - B. 1-2-4-3
  - C. 1-3-4-2

7.4. *Attention pet lovers!*

A small black and white kitten is looking for an owner. The kitten is 8 weeks old and has just had a vet check-up, so you don't need to spend money on it. It's cuddly and friendly and will make a great companion. If you want to adopt it for free, call Anna on 372482047.

- 7.4. The text was written by someone who
- A. has found a kitten
  - B. wants to give away a kitten
  - C. has a kitten for sale

**Zadanie 8**

(0–4)

Przeczytaj tekst, z którego usunięto cztery zdania. Wpisz w każdą lukę (8.1.–8.4.) literę, którą oznaczono brakujące zdanie (A–E), aby otrzymać logiczny i spójny tekst.

Uwaga! Jedno zdanie podano dodatkowo – nie pasuje do żadnej luki.

<      ^v    ≡

## Sundials

People developed a need to know the time of day around 5000 to 6000 years ago, when some well-developed civilisations in the Middle East and North Africa wanted to organize their time better. One of the first time-measuring devices was the sun clock, or sundial, which showed the time of day by the position of the shadow of objects exposed to sunlight.

The Egyptians were one of the first cultures which divided their day into parts. **8.1.** \_\_\_\_ Their moving shadows formed a kind of a clock hand, helping citizens to divide the day into two parts by indicating noon. The obelisks were also used to check the positions of the sun during different seasons. **8.2.** \_\_\_\_ Later, Egyptians added special markers around the base of the monument which showed times of day in a more detailed way.

Another Egyptian shadow clock or sundial, probably the first clock that people could move around, came into use around 1500 BC to measure the passage of "hours". This device divided the day into 10 parts plus two "dark hours" in the morning and evening. **8.3.** \_\_\_\_ Then, the position of the sun clock was changed – it was turned in the opposite direction to measure the five "afternoon hours". But the hours, of course, meant something different than they do nowadays. **8.4.** \_\_\_\_ Why? Because Egyptians (and later Greeks and Romans) divided the time between sunrise and sunset into equal parts.

When mechanical clocks began to be used in Europe in the 14th century, sundials were not forgotten. Sun clocks with equal hours were very popular. In fact, they were used to reset mechanical clocks until the 19th century!

*Na podstawie <https://www.factmonster.com/cool-stuff/calendar/sundials> oraz <https://www.britannica.com/technology/sundial>*

- A. They showed the year's longest and shortest days when the shadow at noon was the shortest or longest of the year.
- B. The first five hours belonged to the morning.
- C. They still measure time in exactly the same way as in the past.
- D. As early as in 3500 BC they started to build obelisks (tall, narrow monuments), which were used to tell the time.
- E. They had a different length in different seasons of the year.

**PRZENIEŚ ROZWIĄZANIA ZADAŃ 5., 7. ORAZ 8. NA KARTĘ ODPOWIEDZI!**

**Zadanie 9**

(0–4)

Przeczytaj tekst. Uzpełnij luki w zdaniach 9.1.–9.4. zgodnie z treścią tekstu. Luki należy uzupełnić w języku angielskim.

<
^v ☰

## A Job for Joe

Today is his lucky day. He finally has a job offer. It is true that when hope is gone, something unexpected happens and your dream finally comes true.

“Congratulations my son, I am so proud of you,” his mother told him on the phone. His father did not say anything. He just held his hand for a moment that seemed like ages. It has always been like that between them. Silence is the best expression of their love. Joe knows that his family has been worried for a long time, although they have never told him that openly.

He can now start thinking seriously about his future. First, he needs to find a house to rent. Something small will do in the beginning, and he can think of getting something bigger when he has saved enough money. He is not in a hurry to start a family yet. He has so many things to learn and do in his life. Besides, weddings are so expensive nowadays.

He remembers the interview. One of the men asked him what his personal qualities were. He told him that he was responsible, caring, open-minded and good with animals. He thought that they would ask him many questions about his education. He did not study agriculture at college so he does not understand exactly why they have chosen him for this job. Perhaps there is something that they saw in him that he is not aware of.

His sisters are happy for him. They have already asked him for video games and trainers.

“Your first salary will be for us,” they said. Yes, he will try to make their dreams come true.

Na podstawie <https://learnenglishwithafrica.com/short-story-a-job-for-joe-with-vocabulary-for-talking-about-jobs-level-a2-b1/>

- 9.1. Joe's father showed that he was proud of his son by \_\_\_\_\_.
- 9.2. When Joe saves enough money, he's planning to buy \_\_\_\_\_.
- 9.3. During the interview, Joe expected to get asked questions about \_\_\_\_\_.
- 9.4. Joe's sisters want him to buy \_\_\_\_\_ for them.

**Zadanie 10**

(0–3)

Przeczytaj tekst. Uzupełnij w e-mailu luki 10.1.–10.3. zgodnie z treścią tekstu, aby jak najbardziej precyzyjnie oddać jego sens. Luki należy uzupełnić w języku polskim.

## Candy making course at Macy's Café

If you have a sweet tooth or a talent for preparing desserts, you should not miss this course being held in our café. You don't need any previous experience in baking and cooking. The course will take you from beginner's level to learning all about rock candies, fudges and other sweets. Here are some details of the course:

- ✿ It will last six weeks, with classes every two weeks on Thursdays.
- ✿ Each class will be taught in two age groups: children aged 6-10, and teenagers aged 11-14. The younger group's first meeting is on 10th May. A week later, on 17th May, the class for teenagers will be organised.
- ✿ The regular price for the whole course is £80. Our loyalty card owners will receive a 10% discount.

Don't miss the chance and surprise your friends and family with hand-made sweets (yes, you can take them home after each class)!

For more information visit us at Macy's Café or call on 264926392.

<
^v ☰

Kasiu, widziałaś ogłoszenie w kawiarni Macy's? Organizują kurs robienia cukierków. To chyba coś dla nas!

Piszą, że nie trzeba  
**10.1.** \_\_\_\_\_, żeby wziąć w nim udział. Mają stworzyć dwie grupy, dla dzieci i dla nastolatków. My byłibyśmy w tej starszej. Zajęcia dla niej rozpoczynają się  
**10.2.** \_\_\_\_\_.  
 Kurs nie jest tani, bo kosztuje 80 funtów, ale **10.3.** posiadacze \_\_\_\_\_ (to my!) otrzymają aż 10% zniżki.

Zapisujemy się?

**Zadanie 11**

(0–3)

Przeczytaj tekst. Spośród wyrazów podanych w ramce wybierz te, które są poprawnym uzupełnieniem luk 11.1.–11.3. Wpisz odpowiednią literę (A–F) obok numeru każdej luki. Uwaga! Trzy wyrazy podano dodatkowo – nie pasują do żadnej luki.

A. guest	B. travel	C. friendly	D. guide	E. visit	F. strange
----------	-----------	-------------	----------	----------	------------

<
^v ☰

## Toy voyaging

Toy voyaging is a **11.1.** \_\_\_\_ hobby which has more and more followers. If you have an old toy which you think needs a holiday, register it on a special website through which you can find a person who will take your toy as a **11.2.** \_\_\_\_\_. If you want, you can become a host for other people's toys, too. It may sound funny, but that's not all. You can plan your toy's missions and tell the host what places you would like the toy to **11.3.** \_\_\_\_\_. The travel log is regularly updated with new information and photos.

*Na podstawie <https://unusual.info/2013/11/14/proof-that-hobbies-are-now-stranger>*

**Zadanie 12**

Przeczytaj tekst. Wybierz poprawne uzupełnienie luk 12.1.–12.4. Zakreśl jedną z liter: A, B lub C.

< ^v ☰

Most people use their computers, tablets and smartphones every day. Imagine that you **12.1.** \_\_\_\_ a mouse or a keyboard because you can control computer software with your thoughts? It is possible with the new NeuroSky MindWave Mobile headset **12.2.** \_\_\_\_ can read your brainwaves. Now you can play **12.3.** \_\_\_\_ games, learn new things faster, and even meditate with the help of this new gadget. The creators of the headset say it's one of **12.4.** \_\_\_\_ devices they have ever produced. Are we only a step away from mind-powered computers?

*Na podstawie <https://time.com/4387701/weirdest-gadgets-ever/> oraz <https://store.neurosky.com/pages/mindwave>*

- |       |                         |                     |                         |
|-------|-------------------------|---------------------|-------------------------|
| 12.1. | A. haven't needed       | B. don't need       | C. aren't needing       |
| 12.2. | A. which                | B. who              | C. whose                |
| 12.3. | A. much                 | B. most of          | C. many                 |
| 12.4. | A. the most comfortable | B. more comfortable | C. the more comfortable |

**PRZENIEŚ ROZWIĄZANIA ZADAŃ 11. ORAZ 12. NA KARTĘ ODPOWIEDZI!**

**Zadanie 13**

Uzupełnij zdania 13.1.–13.4. Wykorzystaj w odpowiedniej formie wyrazy podane w nawiasach. Nie należy zmieniać kolejności podanych wyrazów, trzeba natomiast – jeśli jest to konieczne – dodać inne wyrazy, aby otrzymać logiczne i gramatycznie poprawne zdania. Wymagana jest pełna poprawność ortograficzna wpisywanych fragmentów. Uwaga! W każdą lukę możesz wpisać maksymalnie cztery wyrazy, wliczając w to wyrazy już podane.

- 13.1. My new scooter (*be / steal*) \_\_\_\_\_ yesterday.  
I left it in front of our school and it wasn't there when I finished classes.
- 13.2. What (*you / think / of*) \_\_\_\_\_ the film we saw last night?  
I thought it was brilliant.
- 13.3. We (*not / see*) \_\_\_\_\_ each other since the last holidays.  
I really miss her.
- 13.4. He's studying a lot because he (*want / become*) \_\_\_\_\_  
a famous scientist one day.

