

# Volume of Cubes & Rectangular Prisms

A. Watch the video below. ([Watch 6:11-7:11](#))

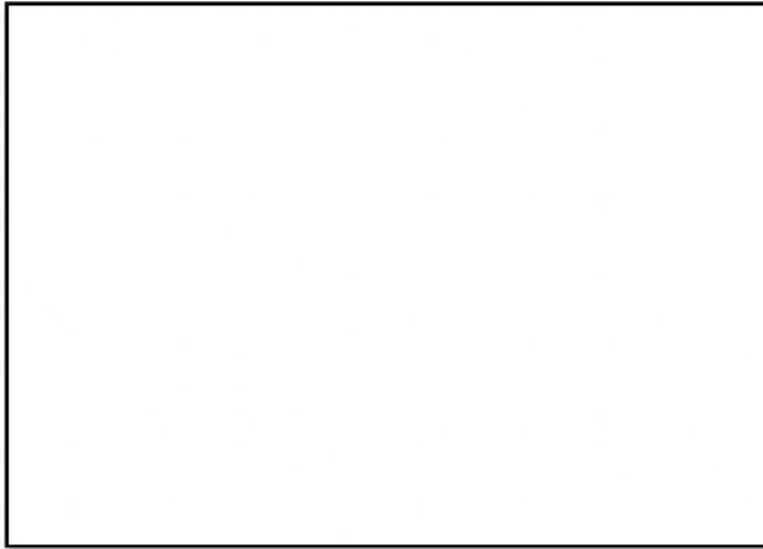

**\*\* Please include:**  
All units!  
Do not put in any unnecessary spaces:  
e.g. 55m not 55 m

**Complete the worksheet below.**

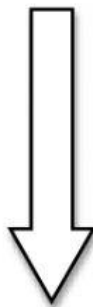

B. FIND THE VOLUME OF THE SHAPES BELOW. PUT ALL ANSWERS CORRECTLY TO THE NEAREST WHOLE NUMBER (NO DECIMALS!)

1)

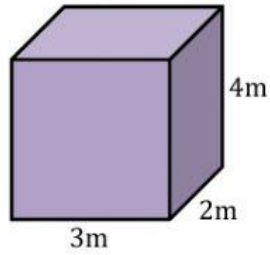

Volume =

2)

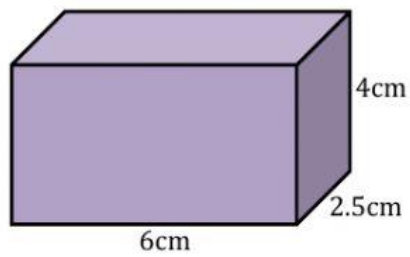

Volume =

3)

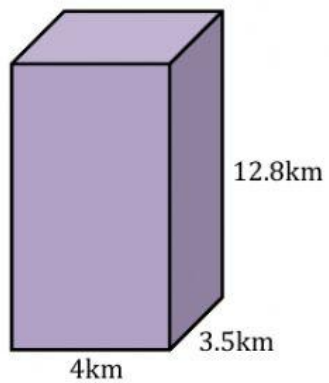

Volume =

4)

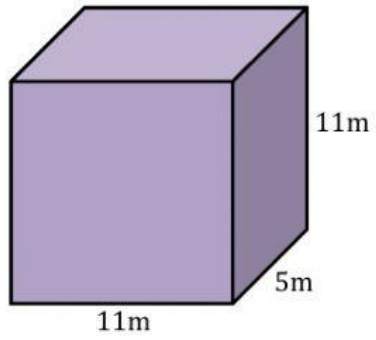

Volume =

5)

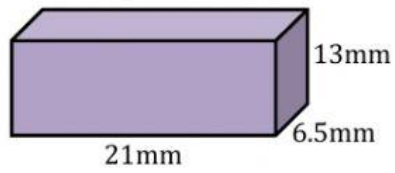

Volume =

6)

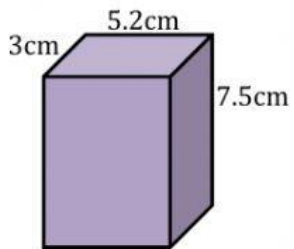

Volume =

7)

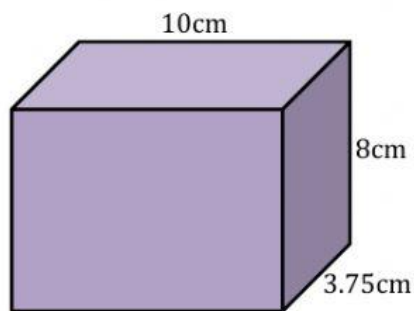

Volume =

8)

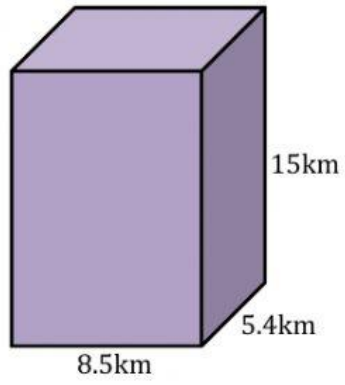

Volume =

9)

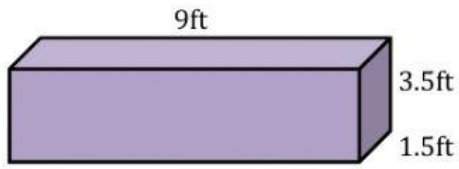

Volume =

10)

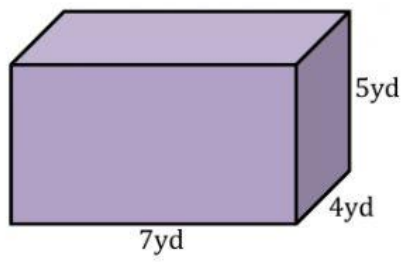

Volume =