

Επιλέγω λέξεις που αρχίζουν από «π»

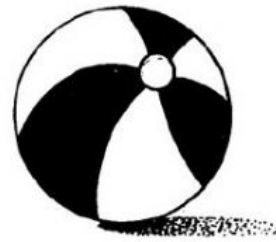

T

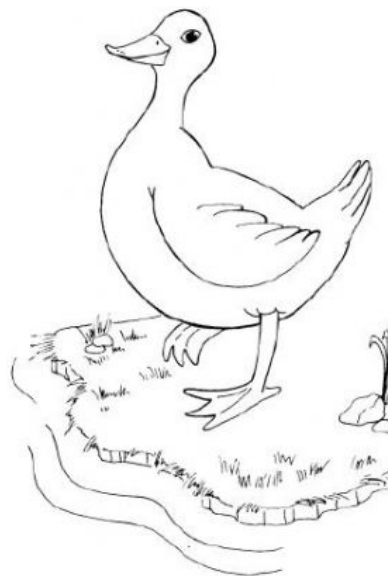
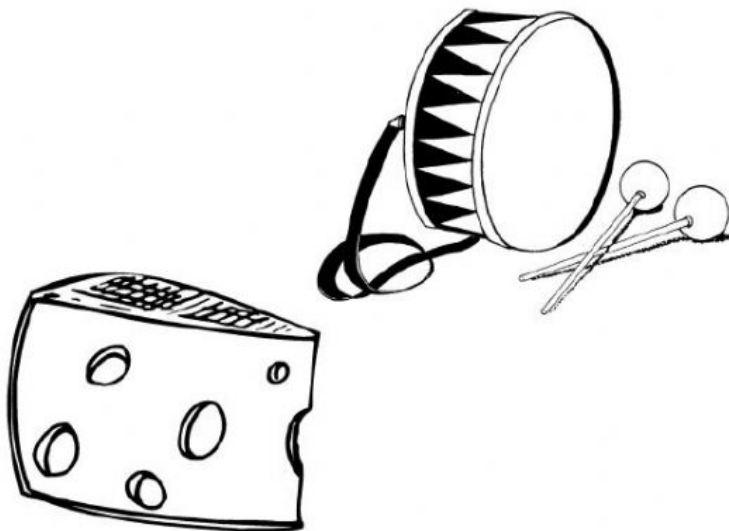

Από το βιβλίο «Πρώτη γραφή και Ανάγνωση-Πρώτος τόμος» του Μ. Μπάνου, εκδ Πατάκη, 1992

A) Διαλέγω τη σωστή συλλαβή

B) Πατάω το μεγάφωνο, ακούω τη λέξη και διαλέγω τη συλλαβή που λείπει.

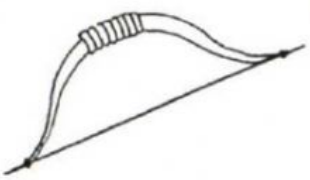
 _____ ξο	τα
	τε
	τι
	το

 _____ χυ δρό μος	τα
	τε
	τι
	το

 _____ τρά δι ο	τα
	τε
	τι
	το

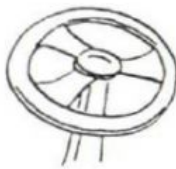
 _____ μό νι	τα
	τε
	τι
	το

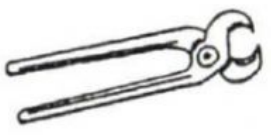
 _____ νά λια	τα
	τε
	τι
	το



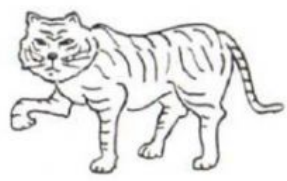









 _____ σσε ρα	τα
	τε
	τι
	το

 _____ γρη	τα
	τε
	τι
	το

 _____ πι	τα
	τε
	τι
	το

Από το βιβλίο «Μαθαίνω τη γλώσσα με εικόνες -1<sup>ος</sup> τόμος» του Καραγιάννη, εκδ Πατάκη, 1992

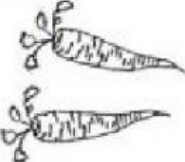
Λέω τη λεξούλα συλλαβιστά (μετρώντας και τα κουτάκια), βρίσκω τη φωνούλα-συλλαβή που λείπει και τη γράφω:

		
γά    ---	έ    λα    ---	ρα    κέ    ---
		
κό    ---	---    μό    νι	---    τρά    δι    ο
		
μά    ---	κα    νά    ---	κα    ρό    ---
		
---    πι	κα    ρό    ---	πο    δή    λα    ---

Λεξιλόγιο: γάτα, έλατο, ρακέτα, κότα, τιμόνι, τετράδιο, μάτι, κανάτα, καρότο, τόπι, καρότα, ποδήλατο

Από το βιβλίο «Μαθαίνω τη γλώσσα με εικόνες -1<sup>ος</sup> τόμος» του Καραγιάννη, εκδ Πατάκη, 1992