

Διαλέγω τις λέξεις που αρχίζουν από «λ»

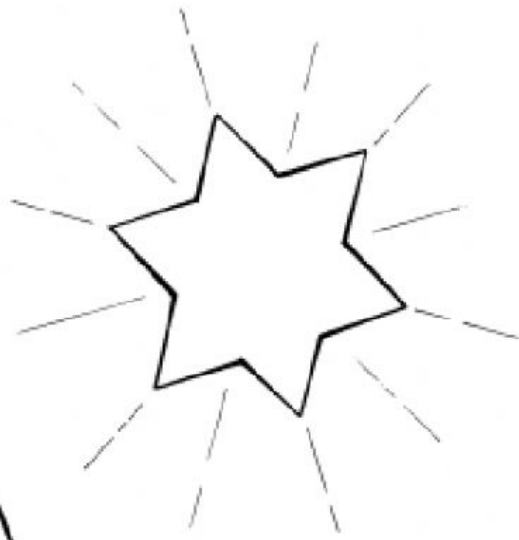

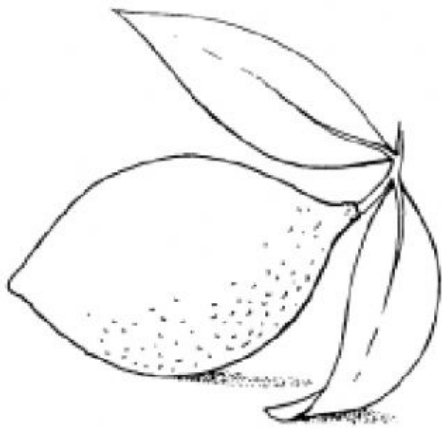

λ

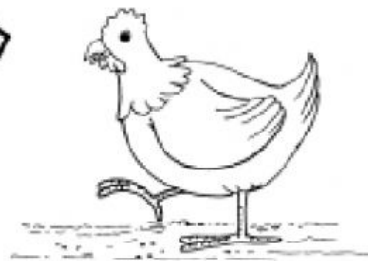
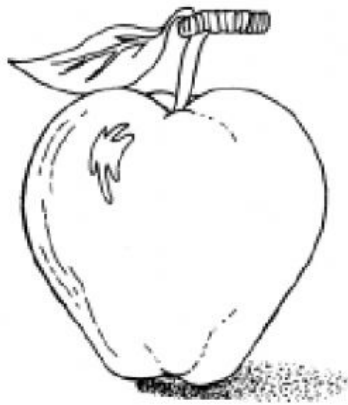

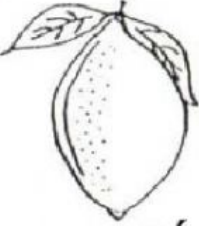

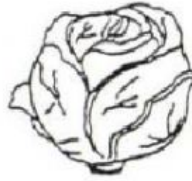
Επιλέγω τη σωστή συλλαβή

 ___ μό νι	λα
	λε
	λι
	λο

 ___ χα νο	λα
	λε
	λι
	λο

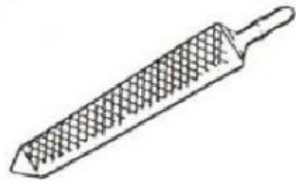
 μή ___	λα
	λε
	λι
	λο

 ___ μα	λα
	λε
	λι
	λο

 ___ μπα	λα
	λε
	λι
	λο

 πο δή ___ το	λα
	λε
	λι
	λο

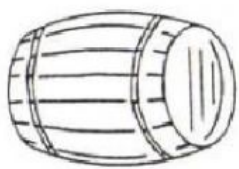
 βα ρέ ___	λα
	λε
	λι
	λο

 τη ___ λέ φω νο	λα
	λε
	λι
	λο

εξιλόγιο: λεμόνι, λάχανο, μήλο, λίμα, λάμπα, ποδήλατο, βαρέλι, τηλέφωνο

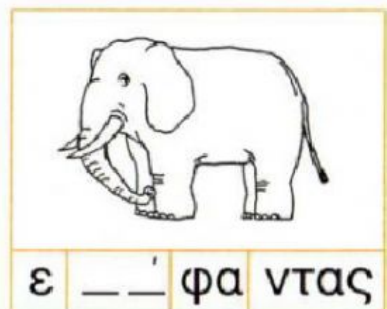
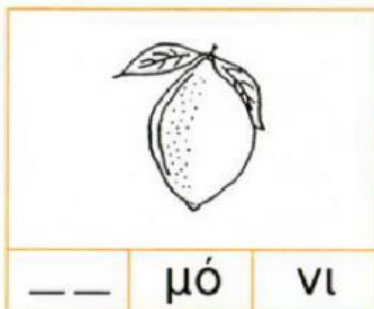
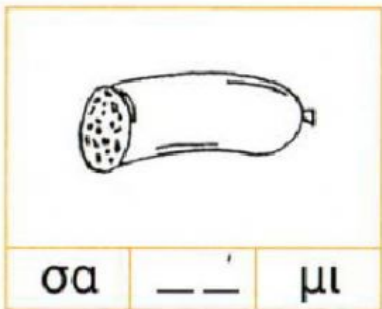
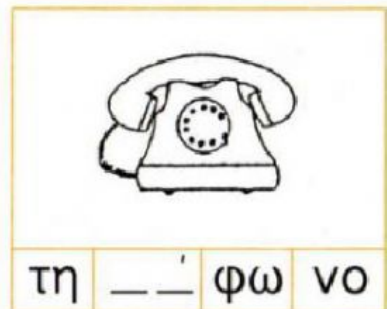
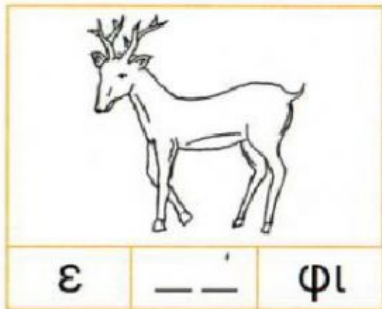
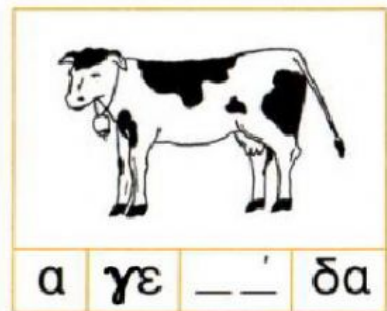
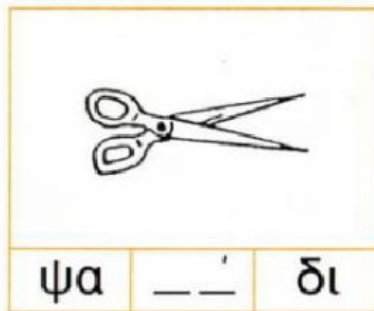
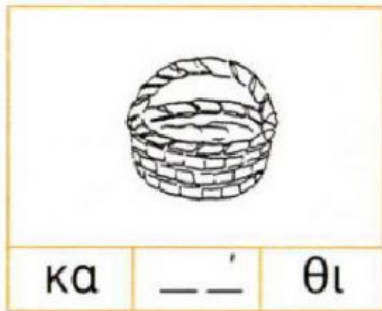
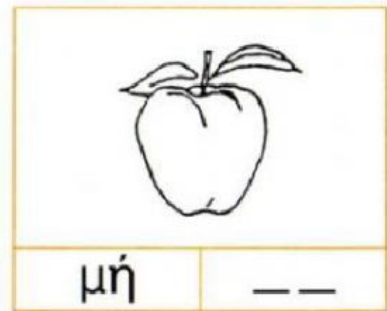
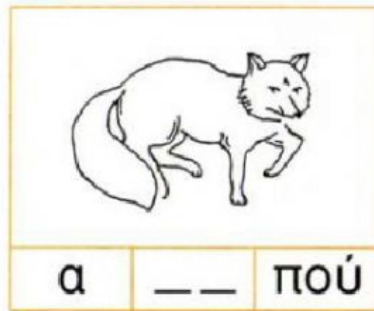
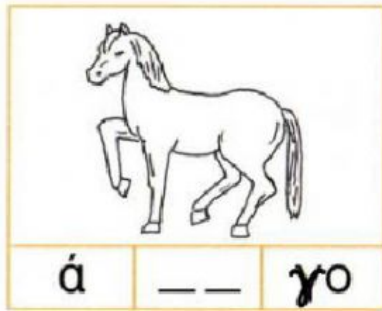

Λεξιλόγιο: άλογο, αλεπού, μήλο, καλάθι, ψαλίδι, αγελάδα, ελάφι, καπέλο, τηλέφωνο, σαλάμι, λεμόνι, ελέφαντας